

LUXMAN

INTEGRATED AMPLIFIER L-507Z



The integration of sophistication and technical evolution. Introducing our innovative Z series.

Luxman's new generation Z series integrated amplifiers.

The L-507Z is the debut model heralding our new generation of amplifier products.

Featuring our newly developed LIFES amplification feedback engine, we look towards the future of Luxman.

This amplifier has realized a dramatic development in musicality that goes far beyond its class.

L-507Z combines advanced technology and sophisticated functionality.

Our new, innovative Z series integrated amplifier generation begins with this superb model.



Our latest amplification feedback engine brings music
to life with LIFES Version 1.0

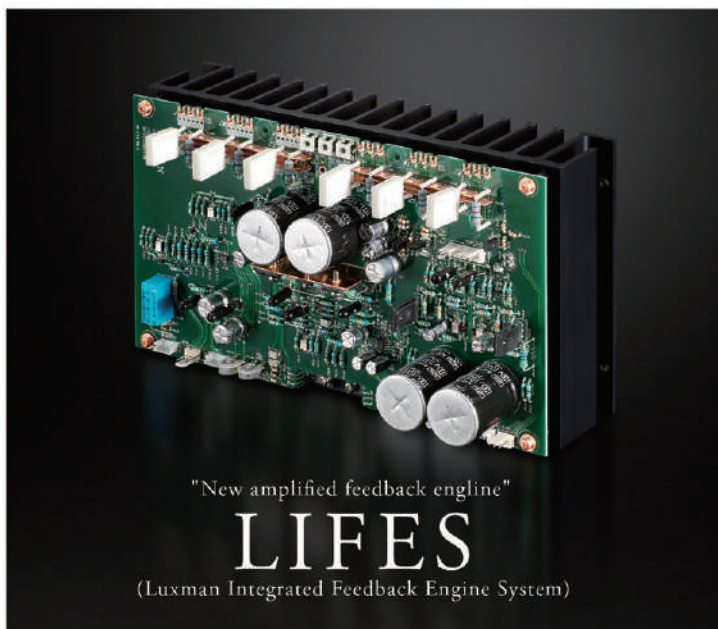

Luxman will celebrate our 100th anniversary in 2025 and we are proud to announce the successor to our ODNF* feedback circuitry, which has contributed to the audio quality of our amplifier products since 1999. We have developed a new amplifier feedback circuit, LIFES*, which has acquired realistic, fresh and rich musicality and overwhelming audio performance. LIFES is based on the technical concept of our epoch-making ODNF circuit and realizes excellent, dynamic characteristics without feeding back any of the original audio input signal to the main amplifier, achieving a remarkably natural sound quality, almost if it were a non-feedback equipped circuit. The design has been conceived and expanded upon from first principles using simulation technology and painstaking research. By repeatedly auditioning, rigorously scrutinizing and combining specially selected components, we have achieved supreme performance characteristics and a level of quality suitable for use in Luxman's next-generation products. In producing LIFES Version 1.0, by carefully reimagining the entire circuit, we succeeded in reducing the number of paralleled elements while improving performance. The distortion in the amplification stage has been reduced to less than half of our previous system. The output stage features a 3-stage Darlington triple-paralleled push-pull configuration and achieves a class AB power output of 110W+110W (8Ω) and 210W+210W (4Ω). The high output power, comparable to that of a separate power amplifier, effortlessly realizes a natural soundstage, full of energy, to confidently drive any compatible speaker system, and bring out the best of its characteristics.

*ODNF stands for "Only Distortion Negative Feedback".

*LIFES stands for "Luxman Integrated Feedback Engine System".

Chassis housing design that asserts the identity of the series

Large needle VU level meter and 7-segment LED

Needle-type analog VU meters are a symbolic design statement of Luxman's solid state integrated amplifiers. The L-507Z is equipped with a large dual meter with bright LED back-lighting and high response characteristics. We have adopted such a display so the movement of the needles synchronizes with the dynamics of your music. In addition, newly included 7-segment LEDs display the attenuation level in between the left and right level meters so that the current attenuation amount can be easily seen from the listening position. The level meter back-lighting and LED display can be turned on and off using the remote control.



Precision hairline finished aluminum top panel

The rectangular chassis housing design features an ultra-thick front panel with a high-quality, blasted white finish. This has become a brand identifier of current Luxman products, with a delicate hairline finished aluminum top panel, a luxurious exterior design adopted for our high-grade amplifiers. The large ventilation slots on the top panel provide sufficient air flow and the entire chassis housing is fabricated from aluminum panels, providing excellent heat dissipation, ensuring the stable operation of this product.



New, high-quality sound technology and features to enhance your listening experience

New LECUA1000

Luxman's New LECUA1000 88-step, electronically controlled attenuator is integrated into the amplifier circuit minimizing sound quality degradation over the full range of volume control. The output section of the preamplifier is equipped with discrete buffer circuitry that confidently drives the subsequent power amplifier stage.

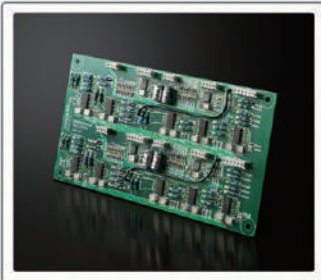

Highly regulated power supply circuit

A highly stable, custom made EI-type power transformer and newly developed, large-capacity filter capacitors (10,000µ Fx 8) are combined in the power supply unit, which provides instantaneous current supply and voltage stability, easily meeting the demands of dynamic music reproduced through capable speakers.



Luxman's original technologies

The L-507Z employs many of Luxman's unique technologies. Beeline construction directs audio input signals via the optimum shortest route through to the speaker output and non-angled circuit board tracing realizes smooth current transmission. A loop-less chassis structure isolates the effects of ground impedance.

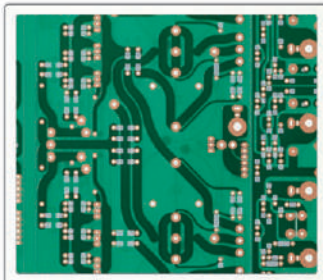

Various functions, switching and controls

The L-507Z features a variety of functions, such as the built-in, newly developed MM/MC compatible phono amplifier circuit that supports high-quality analog playback. Sensitive tone controls, L balance control and a loudness function are convenient for sound quality adjustments. The separate function uncouples the pre and power amplification system and a new mute button has been added to the front panel.



Newly designed parallel headphone outputs

In addition to the standard $\phi 6.3\text{mm}$ output, a new $\phi 4.4\text{mm}$ output has been added, with independent left and right ground wiring that greatly improves L-R separation for the listener who wants to enjoy truly three-dimensional sound.



High-quality input terminals

The RCA input terminals for LINE-1 are made from a copper alloy which delivers the conductivity of copper and durability of brass, providing support for audiophile grade cables (20mm pitch for LINE-1 and 18mm pitch for LINE2, 3 and 4).

Low impedance transmission

Large, low resistance, parallel-configured speaker relays transmit the high driving force of a large-scale output circuit without loss. The damping factor has also been improved by direct wiring to the speaker terminals using our proprietary OFC wire that realizes natural signal transmission.



Cast iron feet

The cast iron feet easily support the weight of the L-507Z and they protect delicate music signals from unnecessary vibration due to a characteristic of the design's density gradient, gradually decreasing from the center to the periphery, which makes resonance less likely to occur.

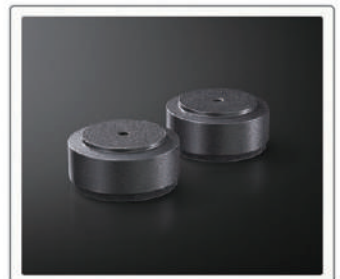

Ergonomic aluminum remote control

The substantial, ergonomic aluminum alloy remote control can also operate compatible LUXMAN CD players released after 1996.



INTEGRATED AMPLIFIER

L-507Z

L-507Z INTEGRATED AMPLIFIER

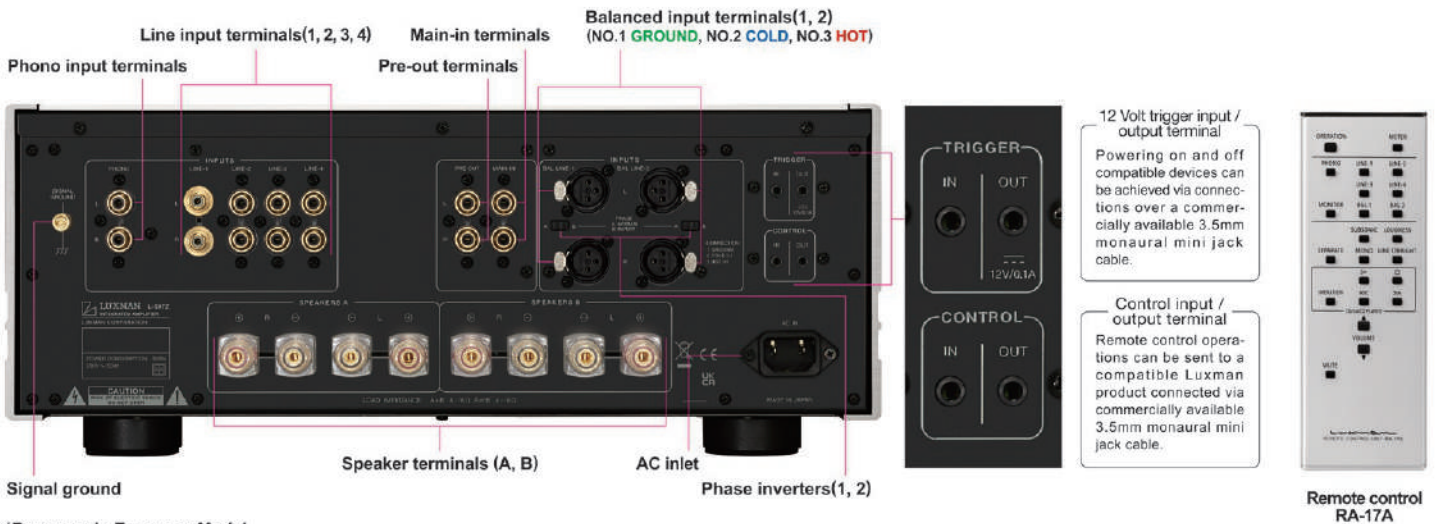
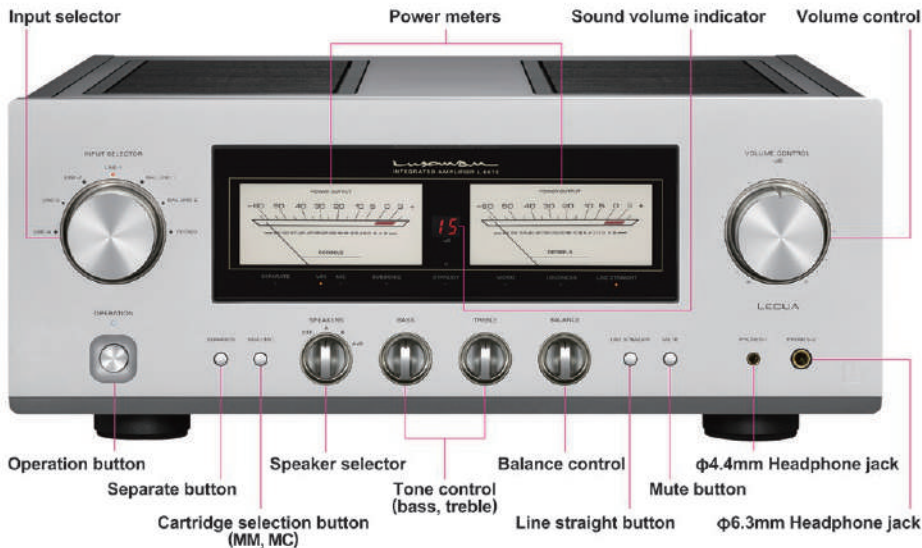

*Rear panel : European Model

SPECIFICATIONS

Rated output	110W + 110W (8Ω), 210W + 210W (4Ω)
Input sensitivity/ input impedance	PHONO (MM) : 2.5mV/47kΩ PHONO (MC) : 0.3mV/100Ω LINE : 180mV/47kΩ BAL.LINE : 180mV/79kΩ MAIN IN : 1.05V/47kΩ
Output voltage	PRE OUT : 1V
Frequency response	PHONO : 20Hz to 20kHz (±0.5dB) LINE : 20Hz to 100kHz (within -3dB)
Total harmonic distortion	0.007% or less (8Ω, 1kHz) 0.03% or less (8Ω, 20Hz to 20kHz)
S/N ratio (IHF-A)	PHONO (MM) : 91dB or more PHONO (MC) : 75dB or more LINE : 105dB or more
Volume adjustment	New LECUA1000
Amplification feedback circuit	LIFES 1.0
Output configuration	Bipolar 3-parallel push-pull
Damping factor	300

Max. amount of tone control	BASS: ±8dB at 100Hz TREBLE: ±8dB at 10kHz
Power supply	230V~(50Hz) / 115V~(60Hz)
Power consumption	350W 86W (under no signal), 0.4W (at standby)
External dimensions	440(W) x 178(H) x 454(D) mm front side knob of 20mm and rear side terminal of 27mm included in depth
Net weight	25.4kg (main unit)
Accessories	Remote control (RA-17A) Power cable
Speaker terminal Supported Y-lug terminal dimension	Width of part a: 15mm or less Width of part b: 8mm or more

* Connection may not be performed depending on the shape of the Y-lug terminal.

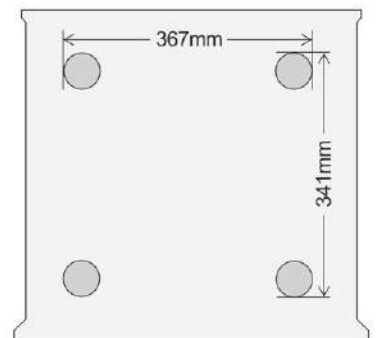

* Slide the phase selector switch to the INVERT position to make the balanced input terminals pin No 2 to change to HOT, and No. 3 to COLD.
* Meter lighting, monaural, subsonic, and loudness can be switched with the remote control.
* Specifications and appearance are subject to change without notice. * The products listed in this catalog do not include line cables. Please purchase cables separately.

LUXMAN

LUXMAN CORPORATION, 1-3-1 Shinyokohama, Kouhoku-ku, Yokohama-shi, Kanagawa 222-0033, Japan
Tel: +81-45-470-6980 Fax: +81-45-470-6997 www.luxman.com
LUXMAN reserves the right to alter the design and specifications without notice.
All rights reserved LUXMAN CORPORATION



Safety Cautions

To ensure correct use of this product, read the "Owner's Manual" prior to use. Failure to follow all safeguards can result in fire, electric shock, or other accidents.